

METODE & IDEGENERERING

MINDMAPS | BRAINSTORM | TELEFONISK FOKUSGRUPPE | MODIFICERET KJ-TECHNIQUE | TIDSPLAN

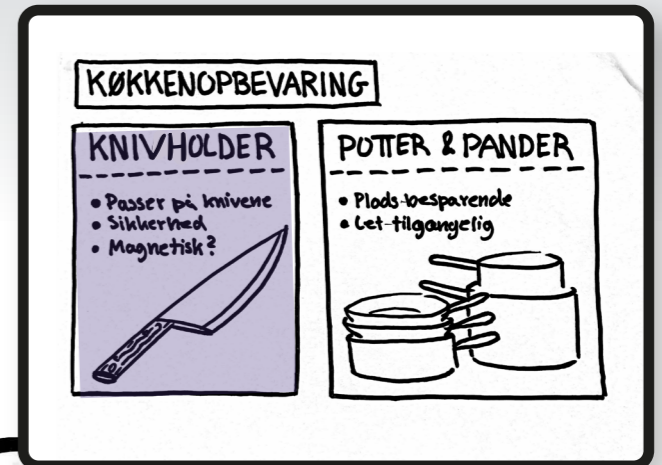
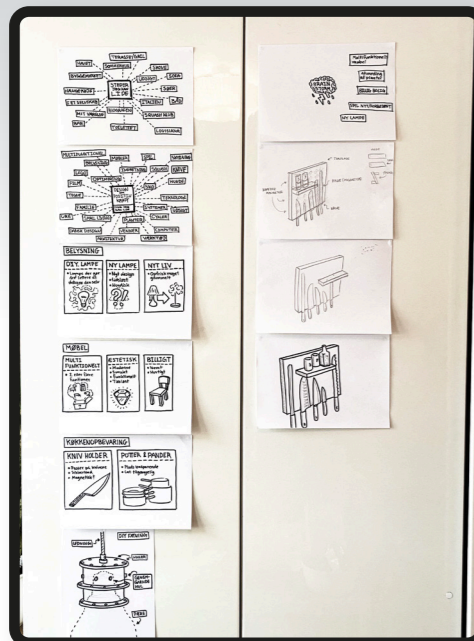
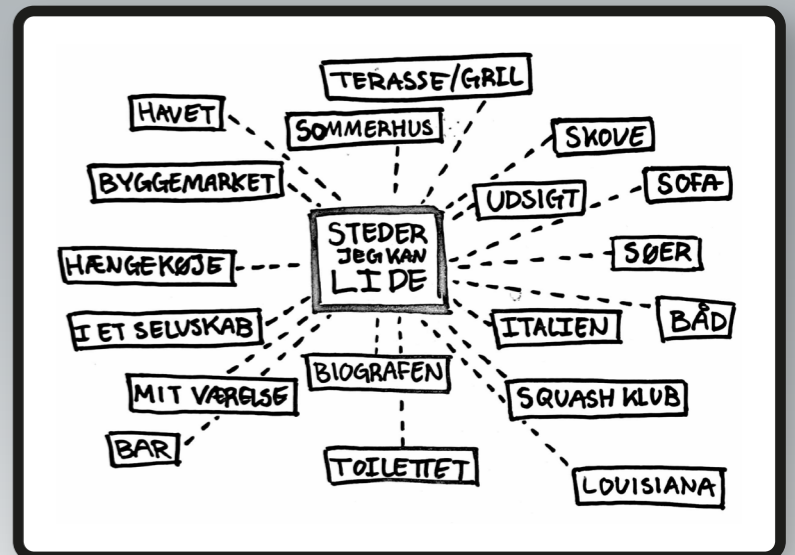
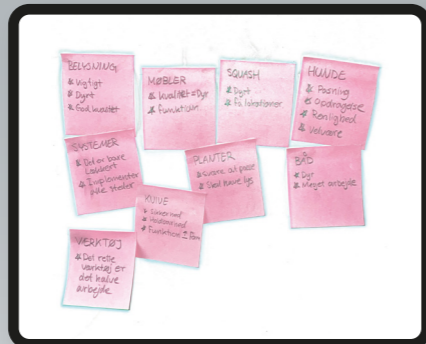
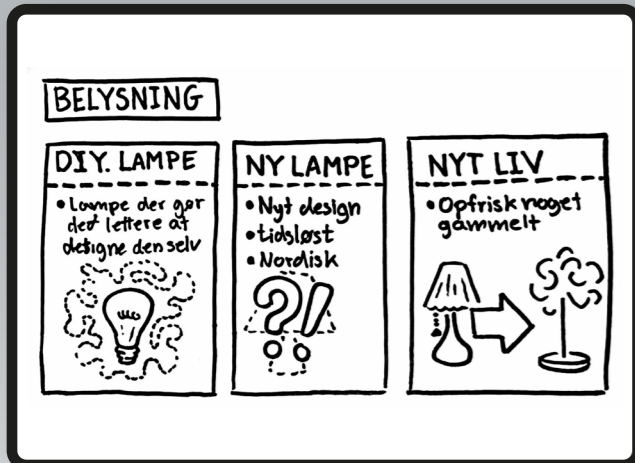
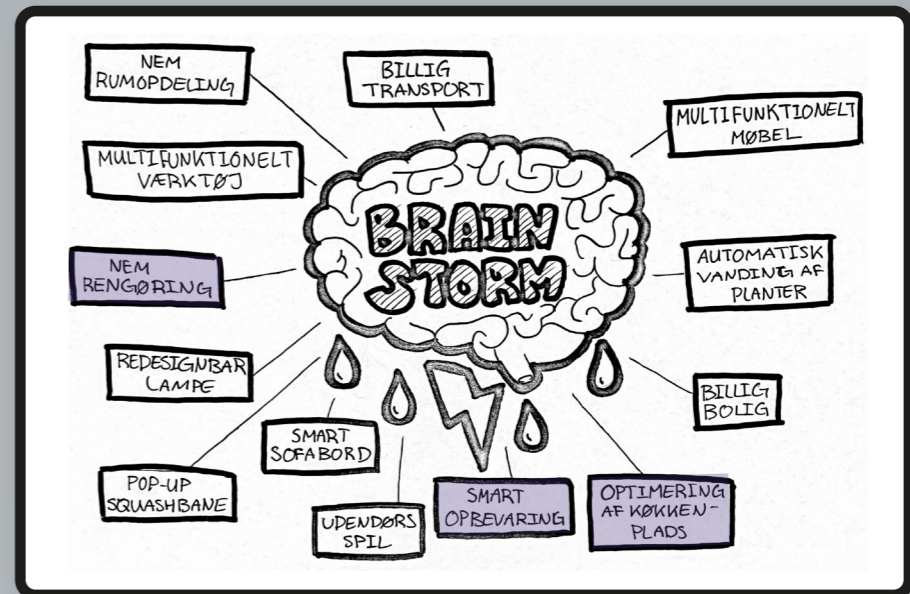
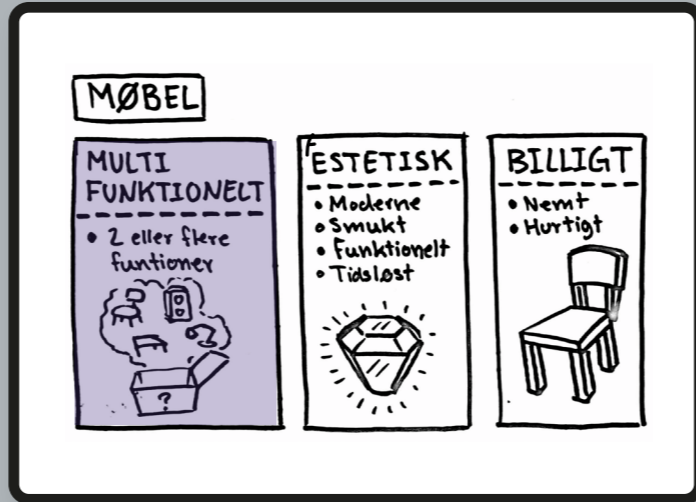
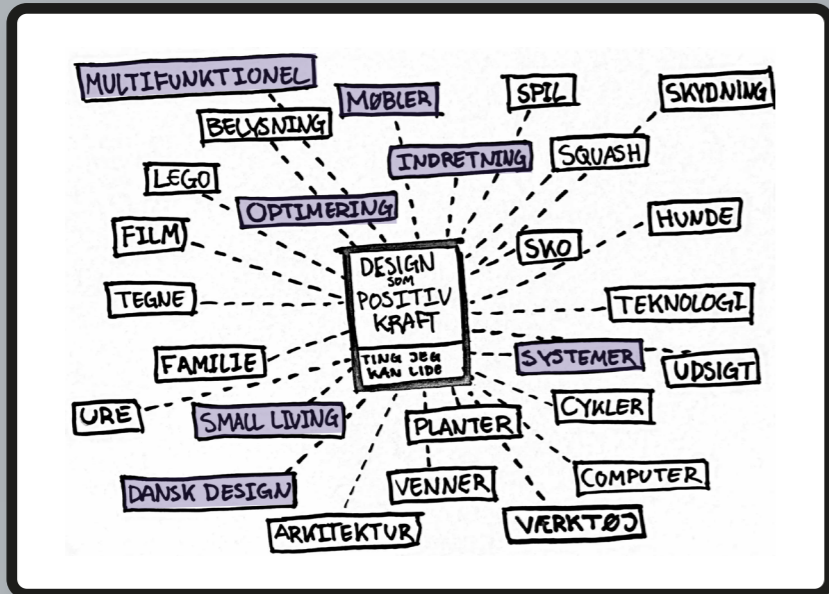

INTERVIEWS

PLADSBEHOV, PRISSÆTNING, TILFØJELSER M.M.

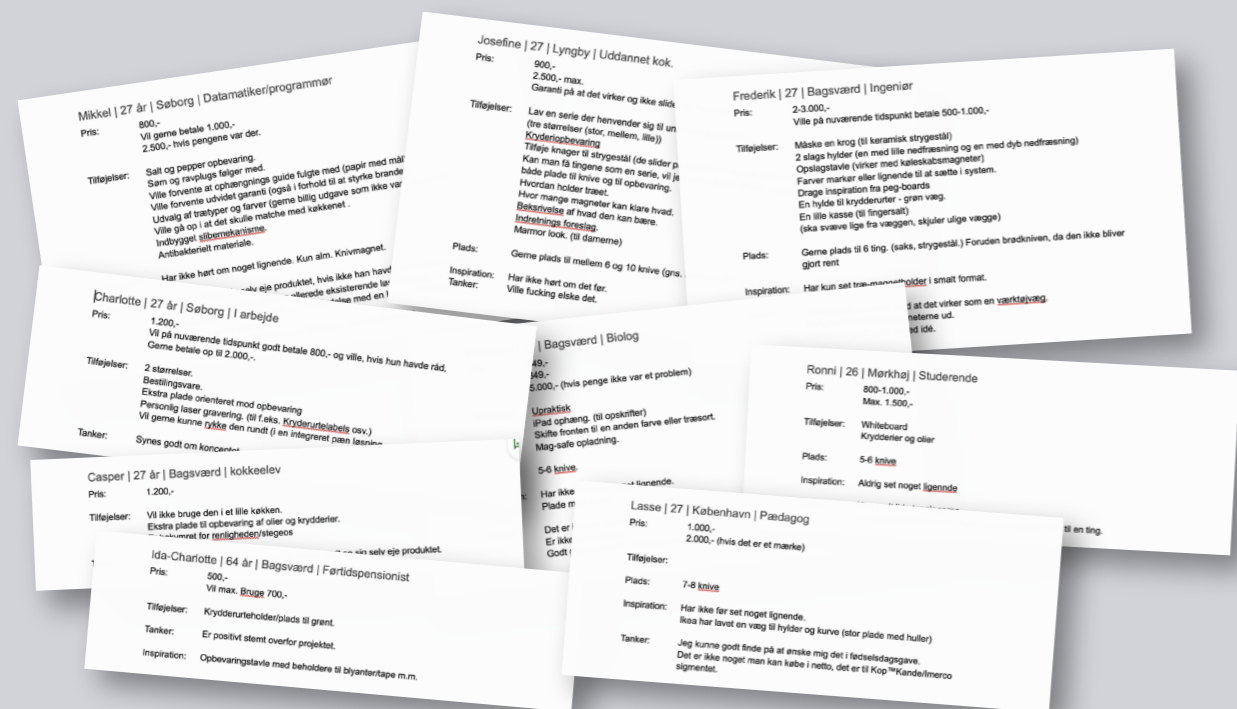

TRÆSORTER

DER ØNSKES EN LYS OG EN MØRK TRÆSORT



VALNØD
JUGLAS NIGRA
KENDT FOR AT VÆRE NEMT AT BEARBEJDE SAMT DETS EVNE TIL AT MODSTÅ STØD

EG
QUERCUS ROBUR
KENDT FOR AT VÆRE NEMT AT BEARBEJDE, SLIDSTÆRKT SAMT RÅDBESTANDIGT

PROTOTYPING

FOR AT FINDE DEN OPTIMALE KNIVAFSTAND



MOODBOARD/INSPIRATION

FORSKELLIGE TYPER AF KNIVMAGNETER

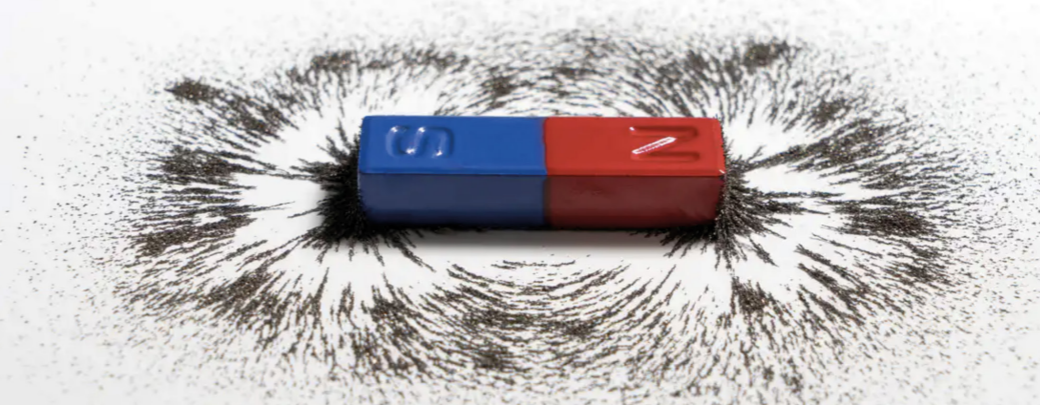
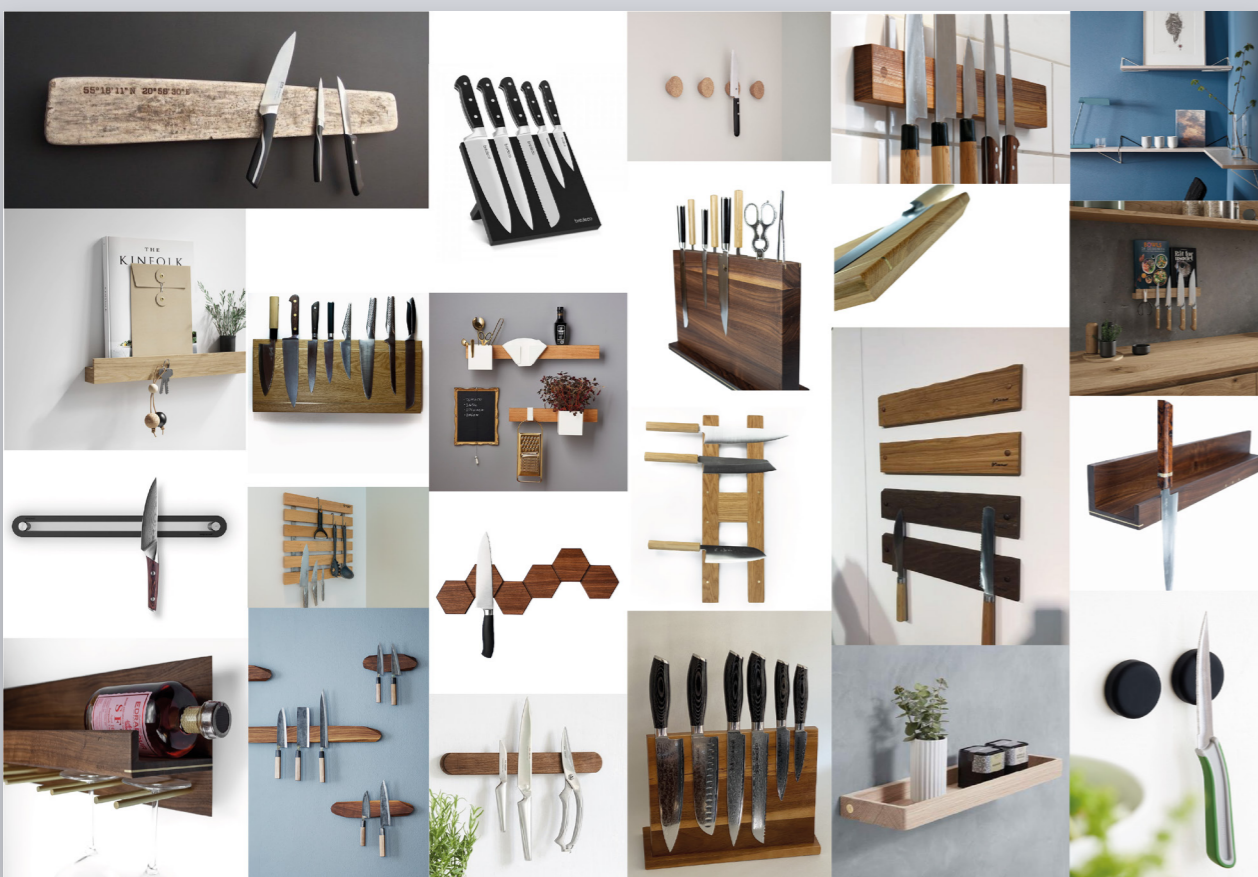

MAGNETERS BÆREEVNE

MED UDGANGSPUNKT I, AT EN HYLDE SKAL KUNNE BÆRE 2 KG. OG HAR 3 MAGNETER IMPLEMENTERET GRUNDET DET INDIREKTE TRÆK OG AFSTANDEN IND TIL MAGNETERNE I PLADEN, VIL HVER MAGNET SKULLE HAVE EN BÆREEVNE PÅ CA. 5,5 KG.

SKABSAFSTANDE

MELLEM OVER- OG UNDERSKABE

UD AF 13 OPMÅLTE KØKKENER SVINGER AFSTANDEN MELLEM 42- OG 61 CM.

RESEARCHEN ER LAVET MED HENBLIK PÅ, AT FINDE DE OPTIMALE MÅL TIL PRODUKTET



TIDLIGE SKITSER

FØRSTE VISION: KVADRATISK PLADE

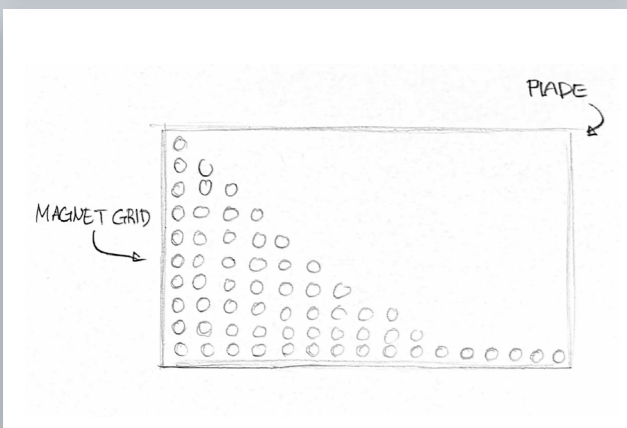
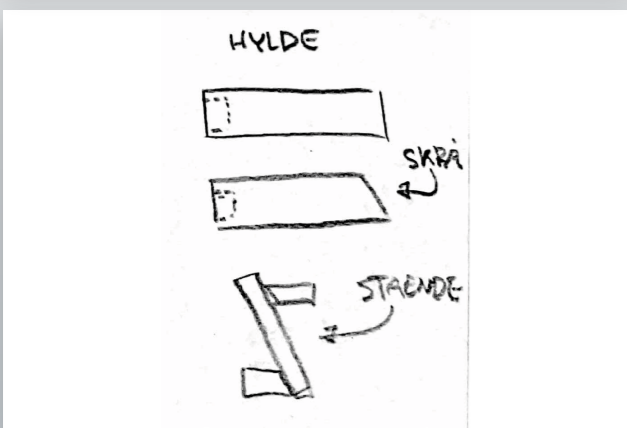
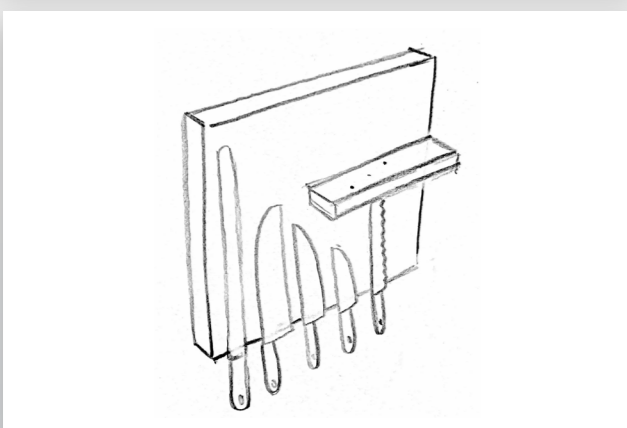
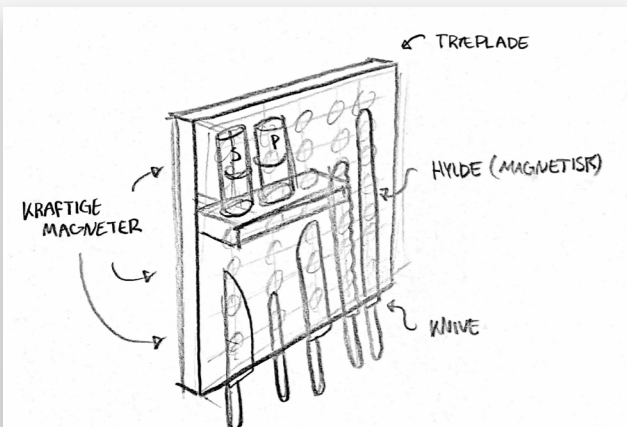

TIDLIGE MOCKUPS

IDEEN OM EN VENDBAR PLADE TAGER FORM

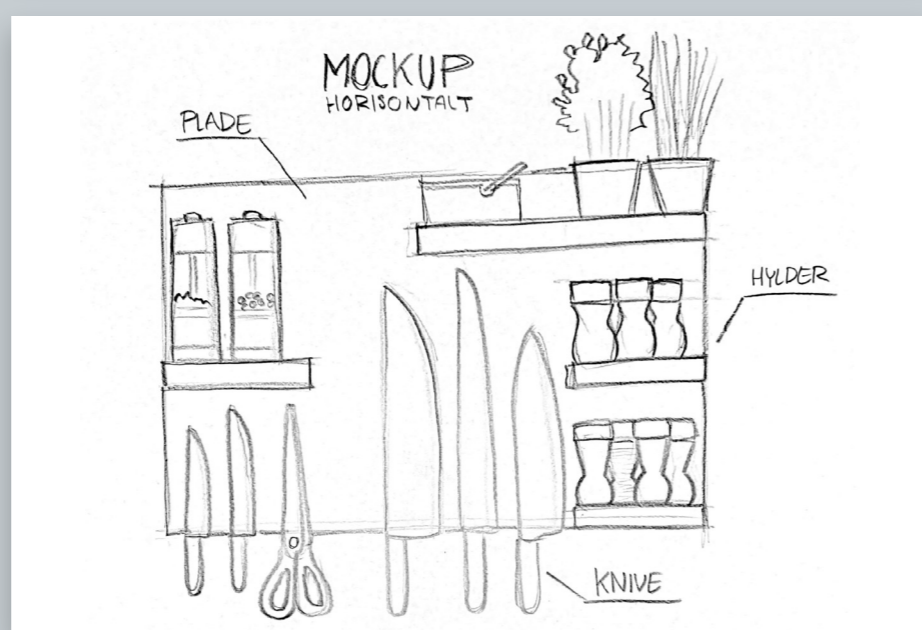
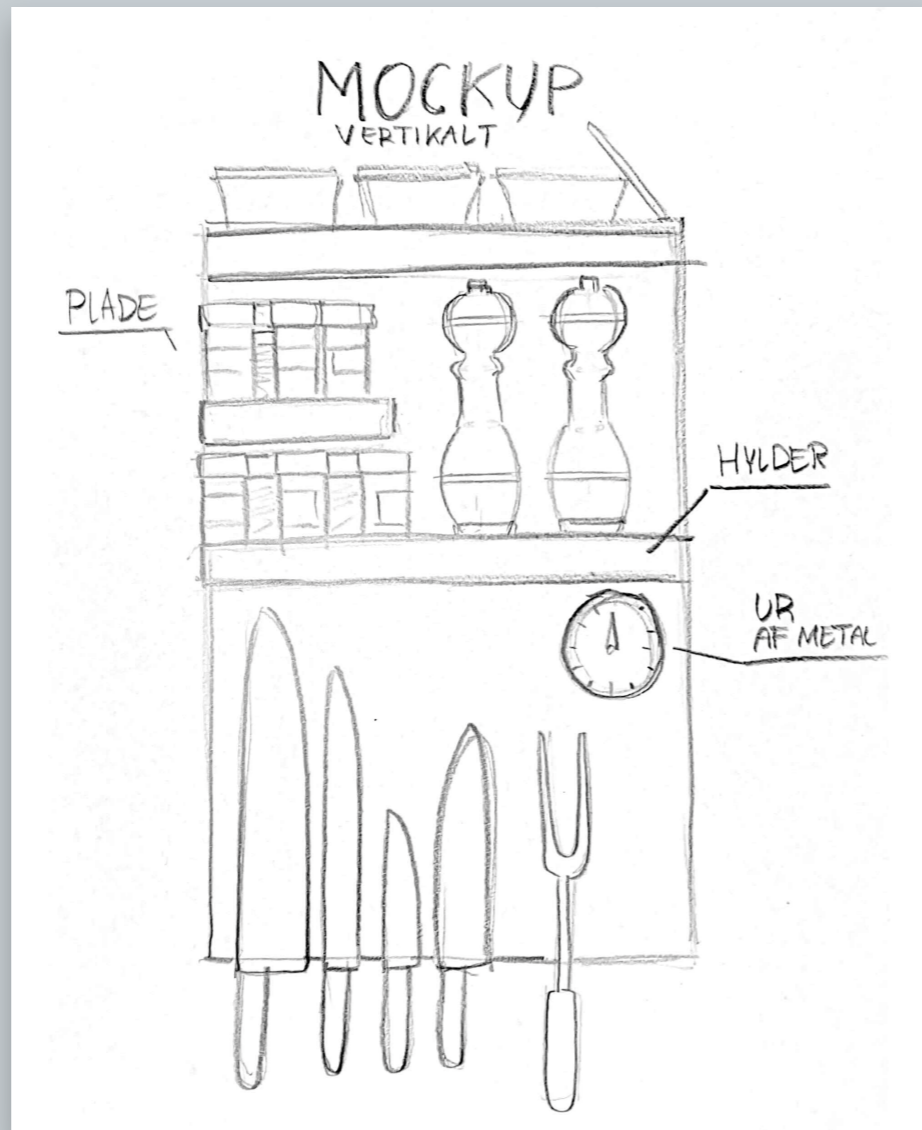

DETALJERING

MAGNETGITTER, PLACERING, CA. STØRRELSE, HÆNGSLER OG BESLAG

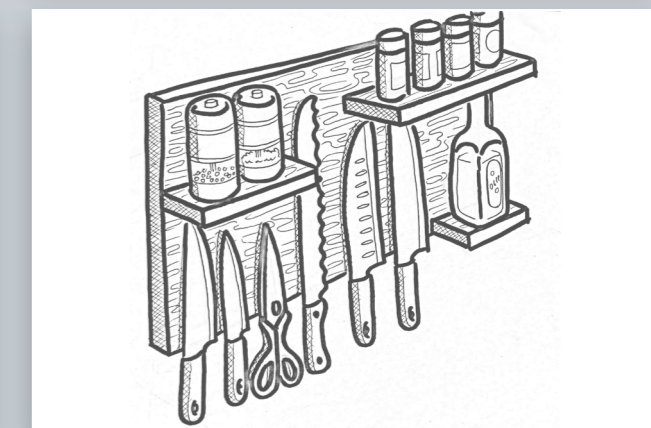
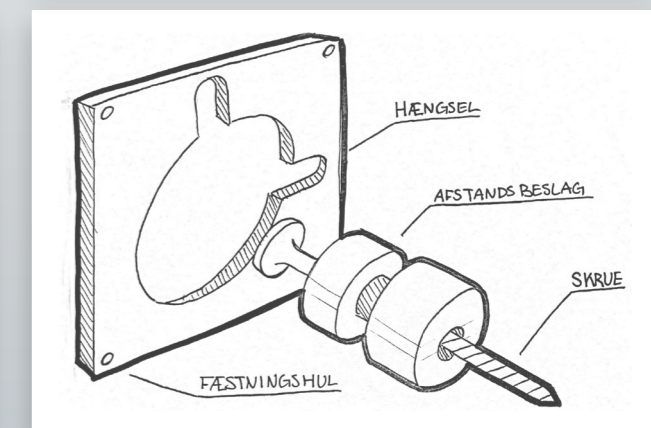
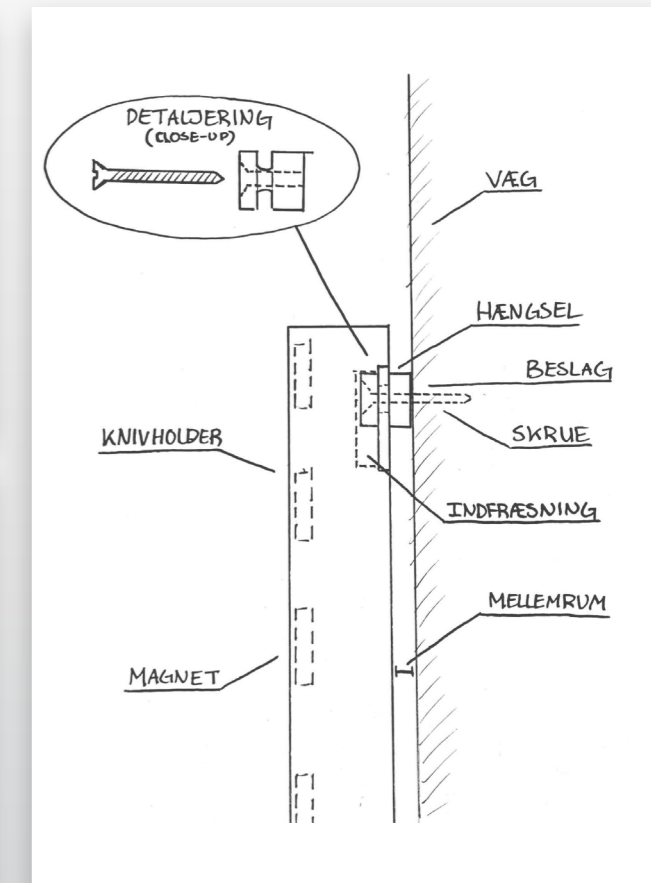
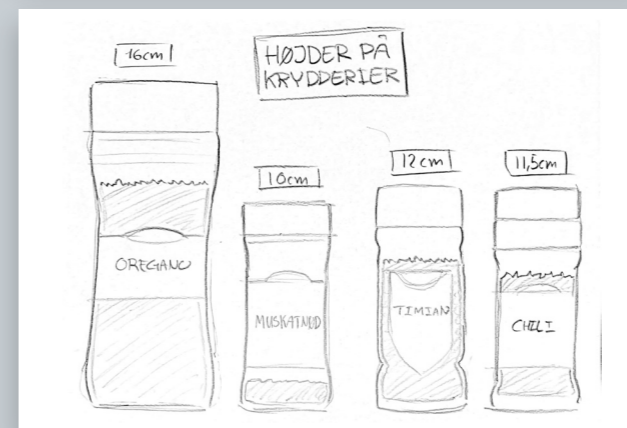
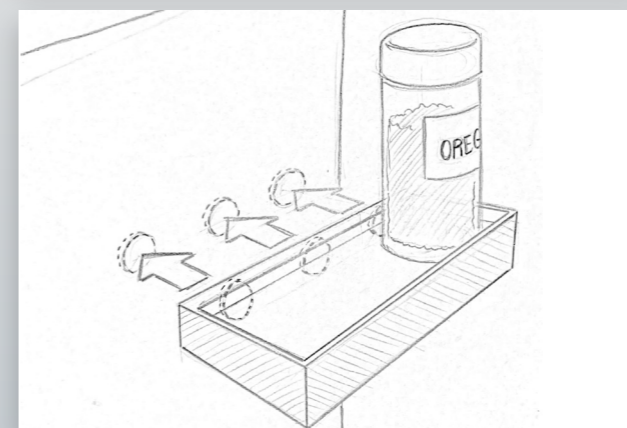
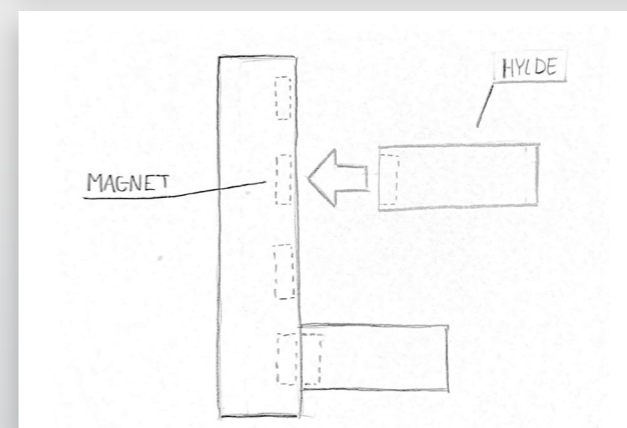
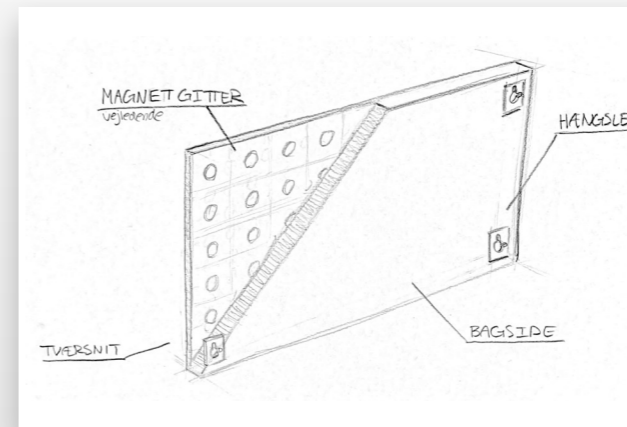

EKSEMPLER

PÅ FORSKELLIGE MÅDER AT OPSÆTTE KNIVMAGNETEN PÅ

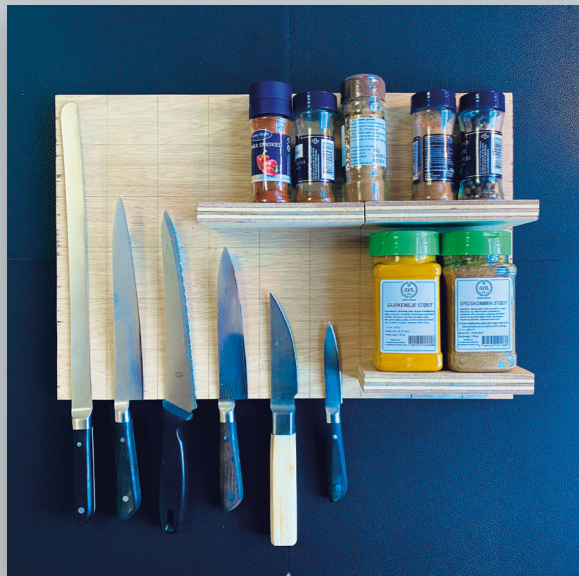
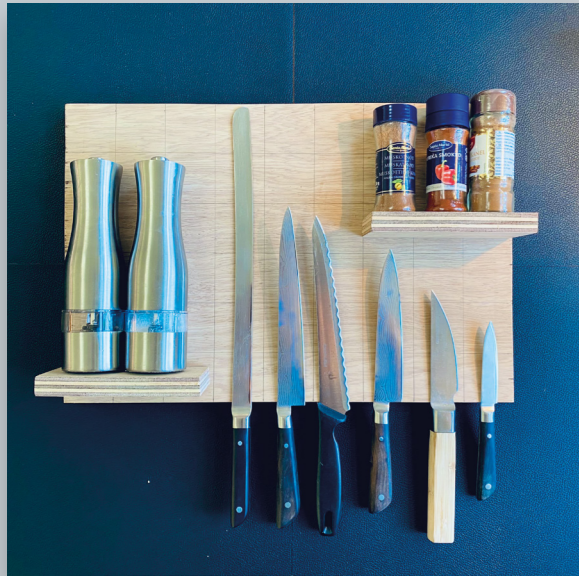

POSITIVT DESIGN

FØR

KNIVMAGNETEN:
INGEN BORDPLADS



EFTER

KNIVMAGNETEN:
MASSER AF
BORDPLADS

- EFFEKTIVT
- KREATIVT
- LEGENDE LET
- OPTIMERET
- STRESSFRIT
- SYSTEMATISK

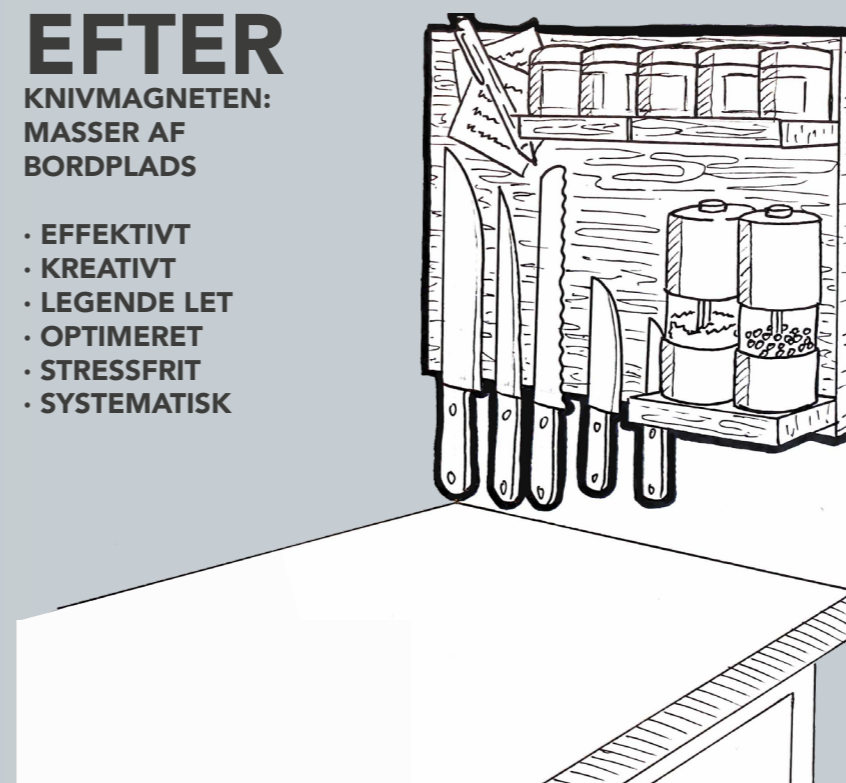

MAGNETER

PÅ BAGGRUND AF MØDER MED MAGNETZ.DK ER FØLGENDE MAGNETER BLEVET UDVALGT



25X7
NEODYMMAGNET
BÆREEVNE: 12 KG.
SKAL PLACERES I
ALLE HYLDERNE

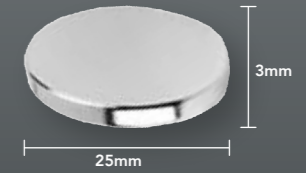

25X3
NEODYMMAGNET
BÆREEVNE: 5,1 KG.
SKAL PLACERES I
HELE PLADEN

SAMLET VIL DER VÆRE BEHOV FOR 60
MAGNETER I PRODUKTET
(54 I PLADEN OG 6 I HYLDERNE)

MÅL

PÅ HELE PLADEN SAMT HYLDER OG CELLER



FAKTA OM OPGAVEN

BRUGTE MEDIER

- SKITSERING I HÅND
- TURBOSCAN APP
- ADOBE ILLUSTRATOR 2021
- ADOBE PHOTOSHOP 2021
- CANON REBEL I7 KAMERA
- APPLE NOTES
- GOOGLE SHEETS
- GOOGLE DOCS
- SKETCHUP WEB
- LYSBOKS



UENDELIGE MULIGHEDER

INDRET DIN KNIVVEN SOM DU ØNSKER, BÅDE HORIZONTALT OG VERTIKALT

FARVEVALG

VALNØD EG



ENTREEN

KAN OGSÅ BRUGES SOM NØGLEHYLDE OG OPSLAGSTAVLE



KNIVVEN

